

GM-200 Plus MASSAGE CHAIR
OPERATION INSTRUCTIONS

SAVE THESE INSTRUCTIONS

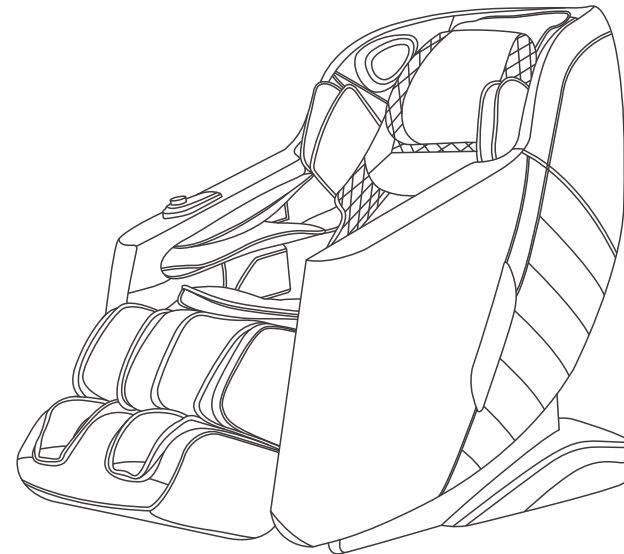

此页无需打印

技术要求:

1. 印刷表面不能模糊不清、不得有漏印、错印、混色、重影、色差、色薄、花痕、表面异物等影响外观的不良现象。
2. 文字、图案印刷不得有断字、断线、残缺、粗细不均、字体粗细偏差、锯齿等不良现象。
3. 印刷表面不得有斑点、针孔、边角漏印、桔皮等不良现象。
4. 印刷需符合设计文档。
5. 具体内容参考电子文档。



尺寸: (L x H) mm 双页285x210mm	型号: A203-17 新西兰亚历克斯	文件名称	说明书-英文	设计变更				
材料: 105G双铜纸	印刷要求: 如图	成品号	/	版本号	A1.0	变更内容	修改人	变更日期
		表面处理	/					
		数量	/					
		图纸比例	1:1					
		公差	/	第一视角		iREST 艾力斯特健康科技有限公司		
编 辑 沈丽佳 2023.06.15	审 核	批 准						

GM-200 Plus MASSAGE CHAIR

OPERATION INSTRUCTIONS

SAVE THESE INSTRUCTIONS

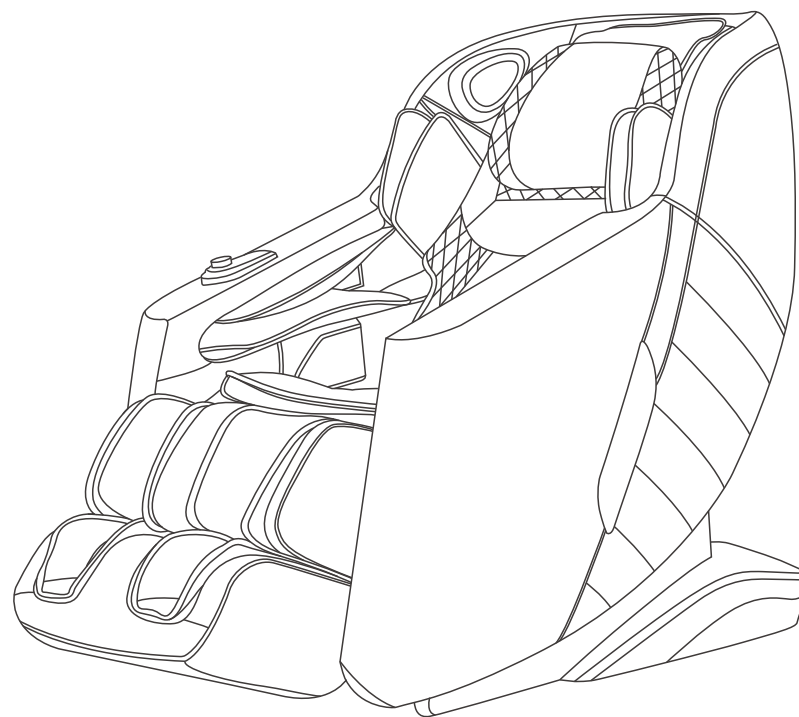

Thanks for purchasing this product. Please read this manual instruction carefully in order to know how to use this product correctly before operation. Please pay more attention to some important safety warning and keep this manual book properly for future use.

Note: Our company reserves the right to change and explain the design of the product. If there is some difference between the product function in market circulation and the description in the manual, it is a normal update of the product, and our company will not inform you otherwise. The specific product function and color shall prevail in kind.

TABLE OF CONTENTS

Before use

Safety Precautions -----	02-04
Installation parts -----	05
Place massage chair -----	06-07
Before use -----	08-09
Product structure -----	10-13

Usage method

Operation Instructions -----	14-27
Massage close -----	27

Maintain



Cleaning and Maintenance -----	28
--------------------------------	----

Important

Troubleshooting -----	29
Product Specifications -----	30

Safety Precautions must be observed

- Please read all relevant instructions carefully before use.
- The notes marked here will help you to use the product safely and correctly.
- In order to clearly indicate the extent of harm and damage, precautions are divided into **"Warning"** and **"Caution"** that may be caused by incorrect use. Both of them are important for safety and must be followed.

 Warning	Indicates that serious injury or death may result from improper use.
 Caution	Indicates that misuse may cause minor injury or property damage.

- Please pay attention to the symbol before each safety item.

 Forbidden	Absolute prohibition
--	----------------------

The following populations should not use this product

 Forbidden	<ul style="list-style-type: none"> ■ The device is not intended for use by persons (including children) with physical disabilities, sensory or neurological impairments or who lack experience and common sense, unless they are supervised and instructed in the use of the device by those responsible for their safety. Children must be supervised to ensure they do not play with instruments. ■ Patients with osteoporosis. ■ Patients with heart disease or wearing electronic medical devices such as a pacemaker. ■ People who have a fever. ■ Pregnant women or women on their menstrual period. ■ Patients who are injured or have a skin disease. ■ When unsupervised, any children are under the age of 14 and those unconscious are not allowed to use this product. ■ People who are told by their physicians to have rest or who feel unwell. ■ People whose bodies are wet are forbidden to use this product. ■ This product has a hot surface. Persons insensitive to heat must pay attention when using this product. ■ If the supply cord is damaged, to avoid danger, it must be replaced by a professional from the manufacturer, its maintenance department or similar department
---	---



Safety Precautions must be observed

Important safety warnings	
 Warnings	<ul style="list-style-type: none"> ■ Do not allow children to touch any movable part of this product. ■ Use the well-grounded power supply unit suitable for this product. ■ Pull out the plug after use or before cleaning to avoid any physical injury or damage to the product. ■ Operate this product as instructed in this manual. ■ Do not use any parts or accessories which are not recommended. ■ Do not use this product outdoors. ■ Please read the Operation Instructions carefully before operation. ■ Never use this product for any other purpose not listed herein. ■ 20 minutes of usage each time is recommended. ■ Do not use this product if the cover or leather is broken or damaged. ■ Do not drop anything into this product. ■ Never fall asleep while using this product. ■ Do not use this product if you are drunk or feel unwell. ■ Do not use this product within one hour after a meal. ■ Do not use this product with excessive force to avoid any injury.

Safety precautions	
 Caution	<ul style="list-style-type: none"> ■ Check whether voltage is consistent with the specification of this product. ■ Never insert or pull out the plug with a wet hand. ■ Do not let water flow into this product to avoid electric shock or cause damage to this product. ■ Do not pull the power cord when plugging or unplugging it. Rough handling is forbidden. ■ Do not damage the wire or modify the circuit of this product. ■ Do not clean live parts of this product with a wet cloth such as a power switch and plug. ■ Be away from this product in case of power failure to avoid any injury if power is restored suddenly. ■ Stop using this product at once while it works abnormal, and consult your local supplier. ■ Stop using this product if you feel unwell, and consult your health care practitioner.

Storage conditions	
 Caution	<ul style="list-style-type: none"> ■ Storage room temperature: 5 °C to 40 °C. ■ Relative humidity (RH) between 20% and 80%; free of corrosive gases, and a well-ventilated room.

Safety Precautions must be observed

Product service and maintenance	
 Caution	<ul style="list-style-type: none">■ This product should be maintained by the service center designated by the manufacturer only. No user should disassemble or maintain it without permission.■ Do not forget to turn off the main power switch after usage.■ Do not use this product if the power socket becomes loose.■ If this product will be left unused for a long period of time, it is necessary to roll up the power cord of this product and store this product in a dry and dust-free environment.■ Do not store this product at a high temperature or near open flame. Avoid prolonged exposure to direct sunshine.■ Please clean this product with dry cloth. Never use thinner, benzene or alcohol.■ The mechanical components of this product are specially designed and manufactured, so no special maintenance is needed.■ Do not use a sharp object to stab at this product.■ Do not roll or pull this product on any uneven ground. Instead, it should be lifted before moving.■ Please use this product intermittently. Do not keep it working continuously for a long period of time.
Operating environment	
 Caution	<ul style="list-style-type: none">■ Do not use this product in a very moist environment such as the bathroom.■ Stop using this product immediately when the ambient temperature changes sharply.■ Do not use this product in any heavily-dusty or caustic environment.■ Do not use this product in a small space or a place without good ventilation.
Solutions to ordinary malfunctions	
 Caution	<ul style="list-style-type: none">■ If the motor sounds during operation of this product, this is the normal operation sound.■ If the controller cannot work normally, check whether the plug and the power socket are connected reliably, and whether the power switch is turned on.■ If the rated working time is over, this product will automatically activate the power-off button; If this product keeps operating for a long period of time, the temperature protector will stop this product automatically. The product can be used again after half an hour.

Installation Parts

Calf installation instructions

1. After connecting the lower leg and the air tube on the massage chair with the wire harness, untie the fixed pipeline belt and insert the connecting part into the seat frame (Fig. 1).
2. Sleeve the lower leg fixing block on the round tubes on the left and right sides of the lower leg (Fig. 2).
3. Hang the lower leg sleeved with the fixing block on the hook of the massage chair seat frame (Fig. 3).
4. Fasten the lower leg on the massage chair with 4 M4 screws (2 on the left and 2 on the right). Check whether there is any abnormality in the up-and-down turning and whethe

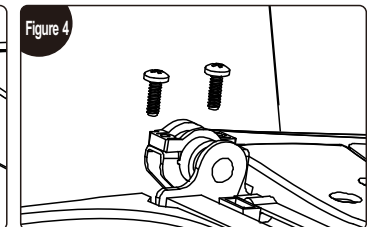
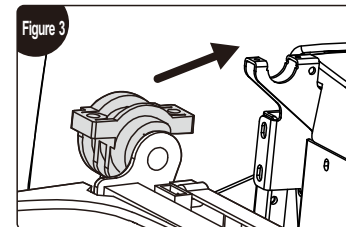
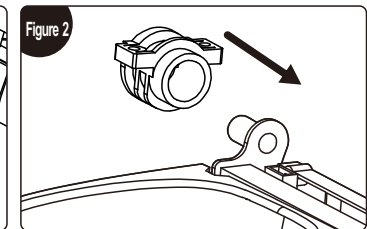
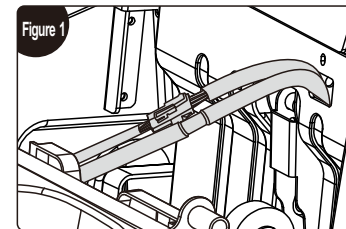

Place Massage Chair

Installation placement

Make sure there is enough space for the massage chair can be tilted at least 15 cm.

Do not expose the massage chair directly to high temperature environment due to sunlight (such as: in front of heating equipment), and place it to where can avoid high temperature and direct sunlight. It is recommended to lay a soft cushion for long-term use in a designated location. When laying the cushion, the size of the cushion should be enough to cover Keep the range where the machine touches the floor and the range where your feet touch the floor.

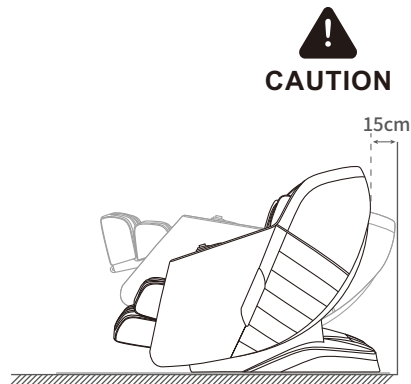

Product lift instruction

Require team work to lift and move the chair to avoid injury.

1. Please lift the massage chair to move it on vulnerable ground such as wooden floor.
2. When moving on a similar wooden floor, it is recommended to lift it. Avoid damage to the casters. When the floor is lifted and moved to the designated position, be careful to keep your hands out of the way to avoid injury, and be careful of your feet being crushed. Do not let go of the unit until the unit is completely flat, the floor may be damaged, therefore, it is recommended to place mats, etc. on the floor.

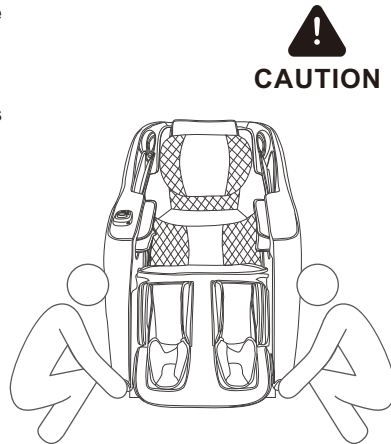

Place Massage Chair

Move method

Use the rear casters to move the massage chair. Move the chair by tilting it down and backward about 45° as shown in the diagram.

NOTE: Excessive force to title will cause the chair to tip over completely and product damage.

1. Before moving, please shut down the machine properly to reset the whole machine, and then cut off the power.
2. Please keep the chair vacant when moving. (People, pets or clutter will not be able to stay on the chair.)
3. When moving, do not cross a drop barrier higher than 2mm or a gap greater than 5mm.
4. When using casters to move this product, single continuous movement is not supported; if the distance exceeds 50 meters, please make this product move slowly and evenly.

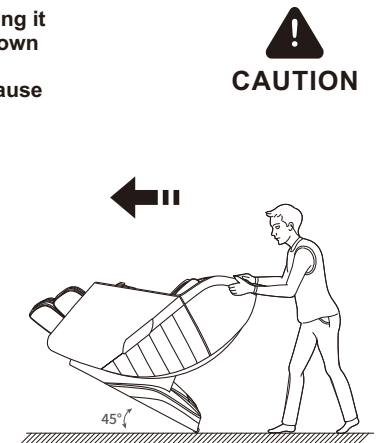

How to disassemble and use headrest cushion and backrest cushion

Using a headrest cushion can reduce the intensity of kneading massage on the neck and shoulders, and you can decide whether to use a headrest cushion according to your needs (recommended to use a headrest cushion). The backrest cushion and the backrest are connected by a zipper (1), and the headrest cushion and the backrest cushion are connected by a zipper (2).

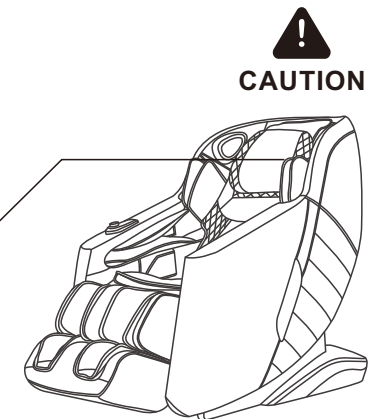
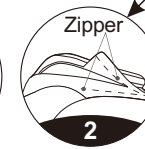

Before Use

Check around

Make sure that there are no people, pets and other objects around the unit.

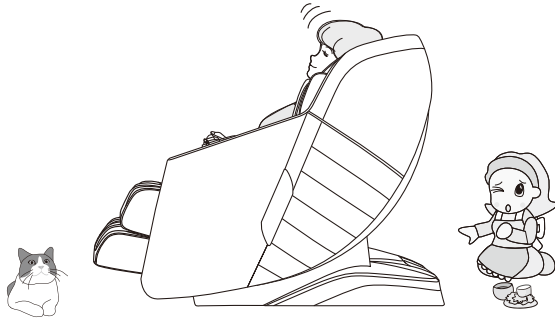

Make sure there are no foreign objects in the gaps of the machine

Before massaging, make sure that no foreign objects are caught in the legs, feet, etc.
Under no circumstances allow hands, feet, and head to penetrate into the area between the lower leg mechanism and main body, or the area between the armrest and the capsule.
Under no circumstances should hands, feet, or head sink under the fabric or leather covering of the massage area.

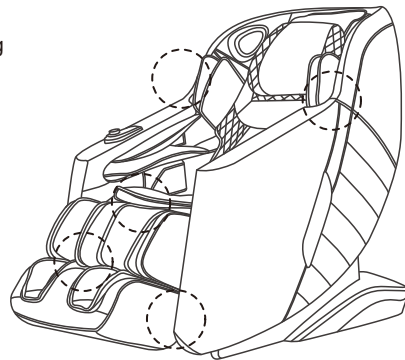

Before Use

Turn on the power



Plug in power cord

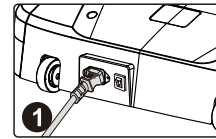

Schematic diagram of power on

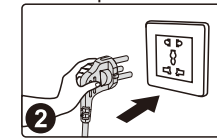

Turn on the power switch ("I" position)

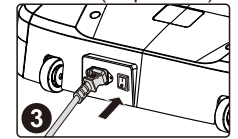

- Please check the power cord and plug for damage before use.
- Please supply power to this product in accordance with the working power requirements of this product's calibration.
- It is strictly forbidden to use a power supply other than the nominal power supply of this product.
- It is strictly forbidden to connect various power conversion devices without authorization to supply power to this product.

Product Structure

Parts description

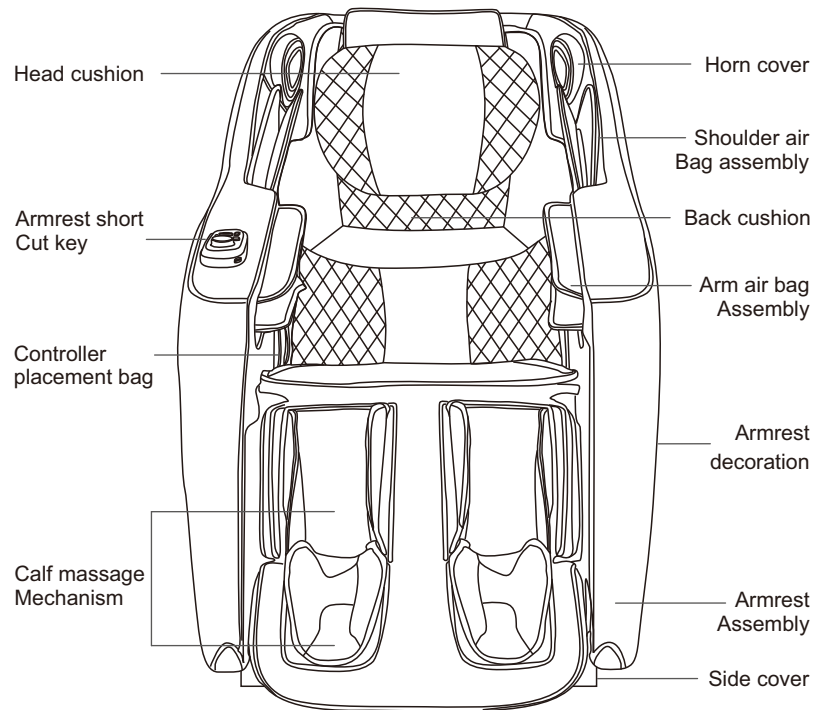

Product Structure

Function distribution

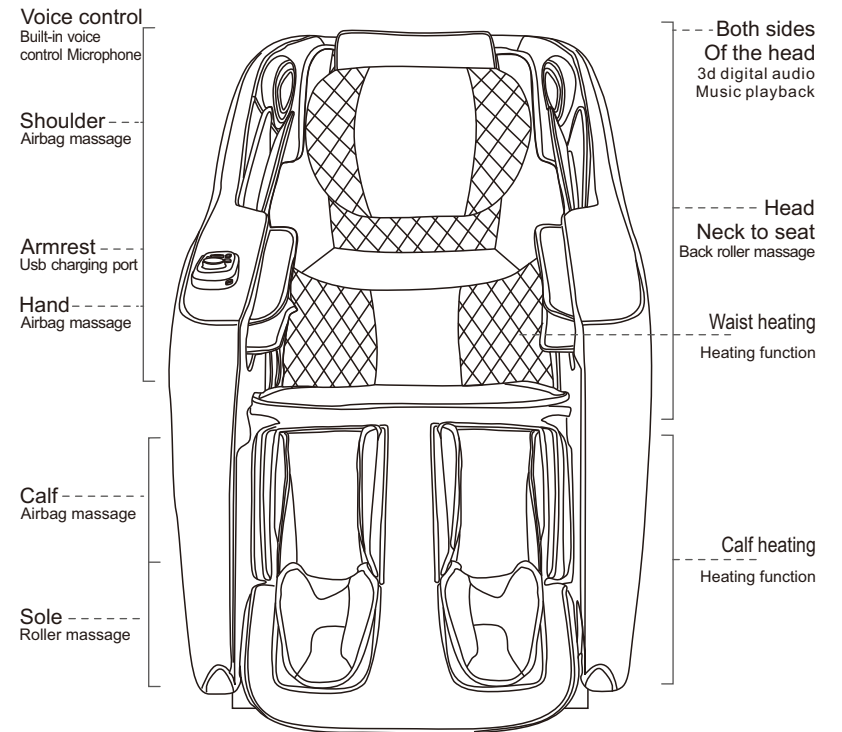

Product Structure

I . Introduction to the remote controller

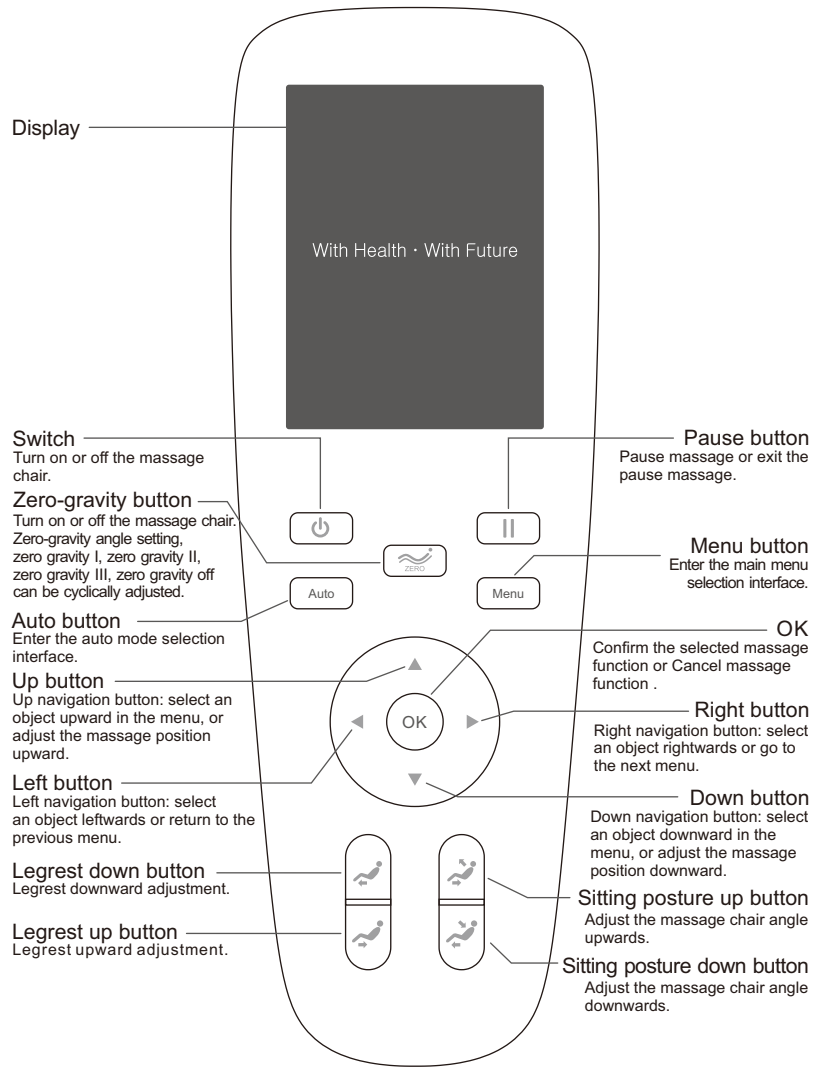

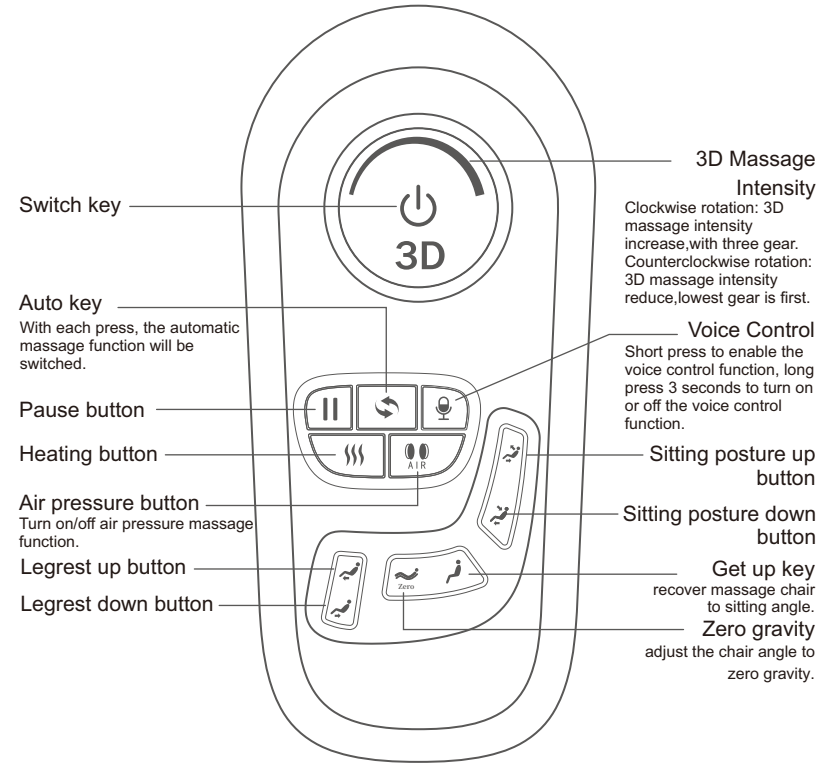

Product Structure

II . Introduction to right armrest shortcut keys





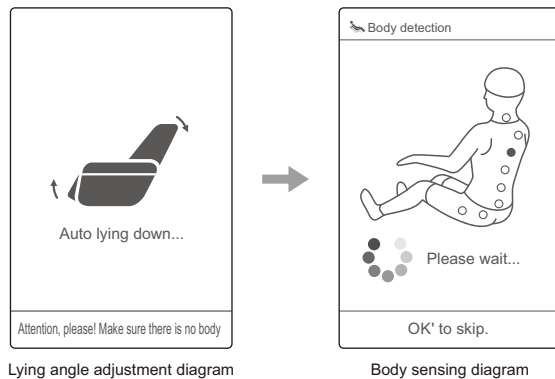

Operation Instructions

III. Start massage

1. Press the remote controller switch key "  " or press the right armrest switch key "  " to power on.
2. After entering the program, select the automatic program according to the remote controller or the voice prompt, and it will automatically shut down if it is not operated for more than 20 minutes.
3. Automatic angle adjustment, after selecting the automatic program, the massage chair will automatically adjust to the zero gravity angle, just wait for the adjustment to be completed. Or you can press the confirm key "  " to skip and go directly to the next step.





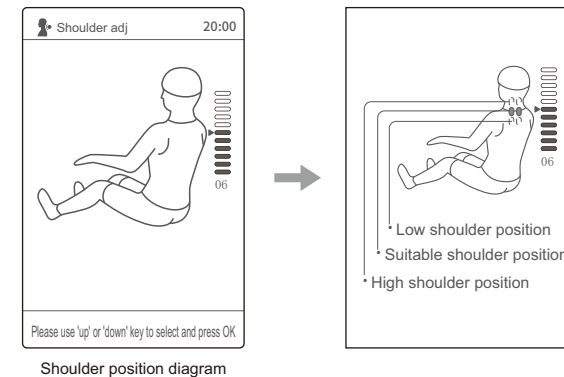

4. Wait for the body sensing to be completed, you can press the confirm key "  " to skip the detection and start the massage directly.
5. The shoulder position is fine-tuned. After the body sensing is completed, the remote controller or the voice prompt will prompt the user to fine-tune the shoulder position. If the massage wheel stops at your shoulder position, you do not need to adjust directly. Press the confirm key "  " to start the massage. If not, Please use the up button "  " and the down button "  " to adjust the massage wheel to your shoulder position and then press the confirm key "  " to start the massage. If there is no operation for more than 20 seconds, the current massage wheel position is directly defaulted to the shoulder position and the massage starts.

Operation Instructions



IV. Pause function(Please use this function after power on)

After the massage chair is turned on, press the pause button "  " or the right armrest pause button "  " to enter the pause state, all massage functions will stop, press the pause button "  " or the right armrest pause button "  " again to resume the previous massage state.

Note: In the suspended state, no other functions can be used except power off. (Bluetooth can play music).

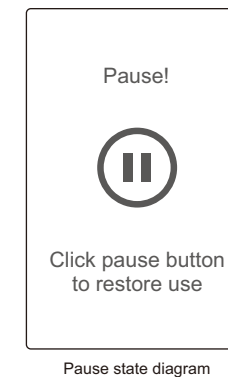

Operation Instructions

V. Auto mode(Please use this function after power on)

1. Auto mode selection

- (1) Press the remote controller menu key " Menu " to enter the main menu; or press the right armrest auto key " Menu " to enter the auto program menu directly; or press the auto key " ↻ " on right armrest to cycle through the auto programs.
- (2) Select the auto mode option, press " OK " to enter the auto mode menu.

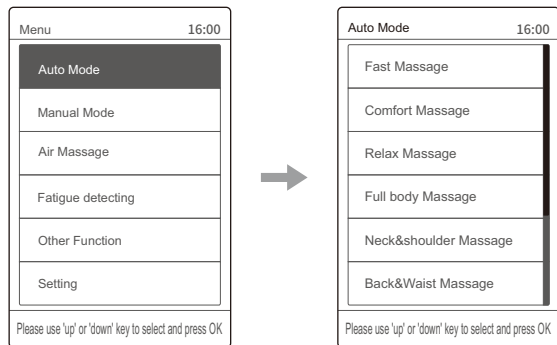

Schematic diagram of automatic program selection

- (3) Select the desired automatic program and press the confirm key " OK " to start the massage.

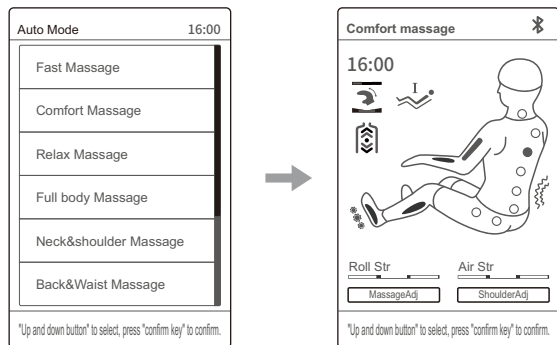

Main interface

Operation Instructions

2. Automatic program introduction

Function	Description
Fast Massage	Quickly experience all massage effects.
Comfort Massage	The most comfortable massage experience.
Relax Massage	Gentle and comfortable deep massage, which can relieve body fatigue and relax the body.
Full body Massage	Deep massage, which can revive body vitality.
Neck&shoulder Massage	According to the unique neck and shoulder massage method, through effective massage of cervical spine and scapula, neck and shoulder pain can be relieved and neck and shoulder fatigue can be improved.
Back&Waist Massage	Focus on the back and waist to relieve back and waist soreness.
Stretch Massage	The lower leg frame and the backrest frame are lifted , effectively relieving tiredness, relieving joint soreness and restoring vitality.
Sport Recovery	Quick recovery of body fatigue after exercising.

Operation Instructions

VI. Manual Mode (please use this function after startup)

1. Message manipulation selection: as shown in the picture below, you can select message manipulation by entering the manipulation selection menu.

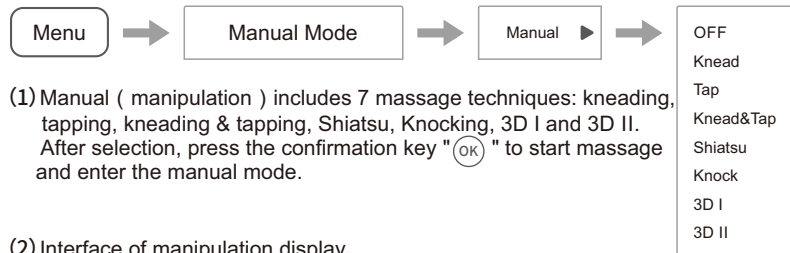

(1) Manual (manipulation) includes 7 message techniques: kneading, tapping, kneading & tapping, Shiatsu, Knocking, 3D I and 3D II. After selection, press the confirmation key "OK" to start massage and enter the manual mode.

(2) Interface of manipulation display.

Function	Manipulation adjustment	
OFF		3 Speed levels 3 Width levels
Knead	Speed.	
Tap	Speed, Width.	
Knead&Tap	Speed.	
Shiatsu	Speed, Width.	
Knock	Speed.	
3D I	Speed.	
3D II	Speed, Width.	

2. Message part selection: as shown in the picture below, enter the part selection menu to select the message part

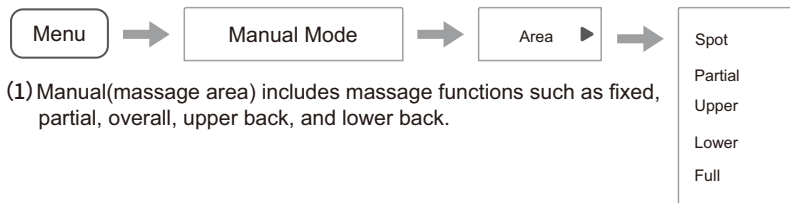

(1) Manual(massage area) includes message functions such as fixed, partial, overall, upper back, and lower back.

Operation Instructions

(2) Interface of part display

Function	Description	
Spot	Fixed point massage	When selecting fixed-point and local massage techniques, you can adjust the massage area by "up" and "down" in the information interface state
Partial	Small range local round-trip massage	
Upper	Upper back round-trip massage	
Lower	Lower back round-trip massage	
Full	Full back massage	

3. Message width selection: as shown in the picture below, enter the width selection menu to select the message width.

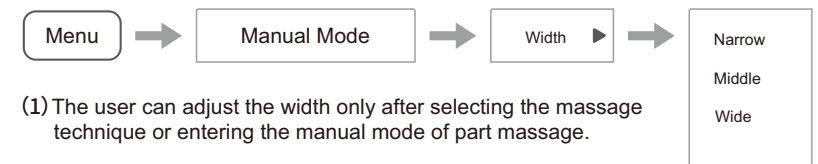

(1) The user can adjust the width only after selecting the message technique or entering the manual mode of part massage.

(2) The message width has 3 levels: narrow, medium and wide. Level 1 is the narrowest and Level 3 is the widest. Please use it in the following message techniques: off, tapping, shiatsu and 3D I.

(3) Interface of width display.

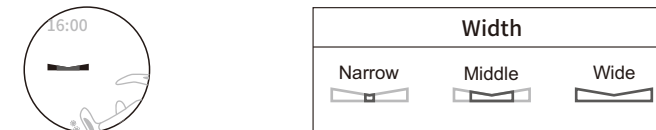

4. Message speed selection: as shown in the picture below, enter the speed selection menu to select the message speed.

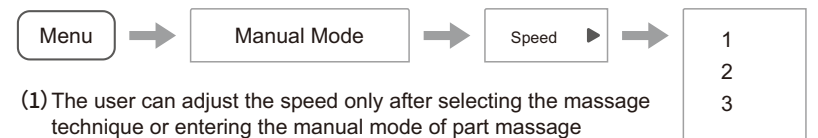

(1) The user can adjust the speed only after selecting the message technique or entering the manual mode of part massage

(2) The message speed has 3 levels. Level 1 is the slowest and Level 3 is the the fastest. The speed cannot be adjusted when the massage technique stops.

Operation Instructions

(3) Interface of speed display.

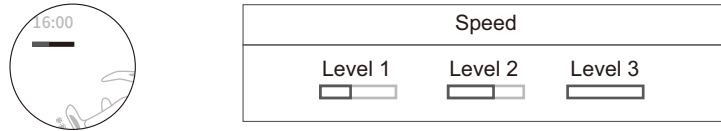

VII. Air Massage (please use this function after startup)

1. Air Massage

(1) Air mode selection: as shown in the picture below, enter the air pressure message menu to select the air pressure mode. The air pressure mode includes upper body air pressure, lower body air pressure, whole body air pressure and air pressure intensity.



(2) Air pressure intensity adjustment: after the air pressure function is turned on, the air pressure intensity can be adjusted. There are 3 levels. Level 1 the weakest, and Level 3 is the strongest.

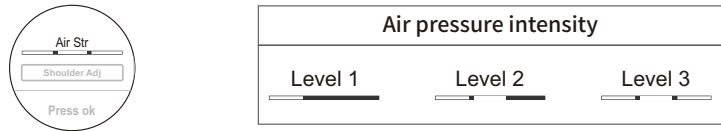

(3) Interface of air pressure display

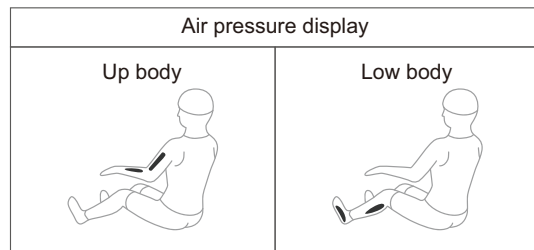

Operation Instructions

VIII. Other function (please use this function after startup)

1. Foot roller

(1) Foot roller: as shown in the picture below, enter the auxiliary function menu to select the intensity of the foot roller. The foot roller massage intensity can be selected from Level 1 to Level 3 or turning off. Level 1 is the weakest and Level 3 is the strongest.



(2) Interface of foot roller display



2. Back heat

Heating switch, as shown in the picture below, enter the auxiliary function menu to select back heat to turn on or off the back heat function.



3. Leg heat

Heating switch, as shown in the picture below, enter the auxiliary function menu to select leg heat to turn on or off the leg heat function.

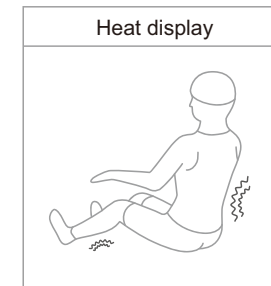

Operation Instructions

IX. Massage Adj (please use this function after startup)

1. 3D str

(1) As shown in the figure below, enter the 3D intensity adjustment menu to adjust the 3D intensity, a total of one to three adjustable levels. Level 1 means the weakest intensity, Level 3 means the strongest intensity.



(2) Or rotate 3D knob  on right armrest to adjust.

2. Air str

As shown in the picture below, enter the air pressure intensity adjustment menu to adjust the air pressure intensity. 3 levels can be adjusted. Level 1 the weakest and Level 3 the strongest. (under the main information interface)



Interface of Air pressure display



3. Time Adj

As shown in the picture below, entering the time adjustment menu can increase or decrease the massage time, and the adjustment range is 0 ~ 40 minutes. When the countdown of the massage time is reduced to 0, the massage is automatically turned off, the back roller is reset, and the posture of the massage chair remains still. (under the main information interface)

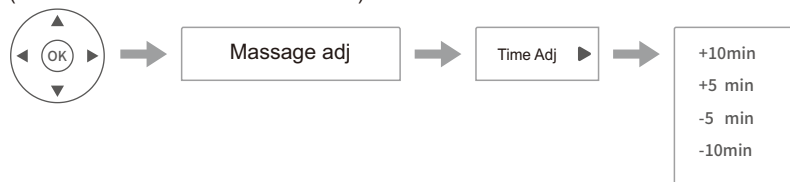

Operation Instructions

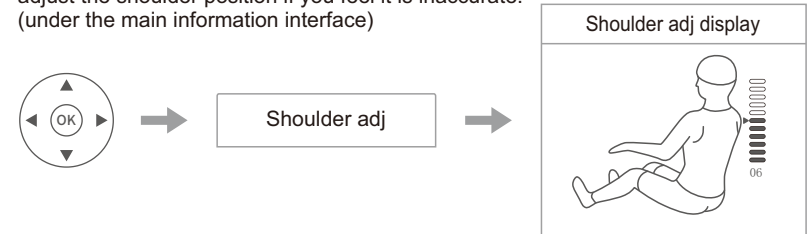

4. Shoulder adj

As shown in the picture below, enter the shoulder position menu to fine tune the shoulder position up or down. When the back roller presses the shoulder, you can adjust the shoulder position if you feel it is inaccurate. (under the main information interface)





X. Angle adjustment

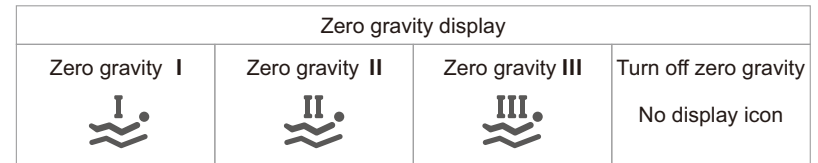

1. Zero gravity

There are 3 levels, corresponding to three set massage chair angles. Press the zero gravity button " " or press the right armrest zero gravity button " " on the manual controller to adjust three zero gravity levels or turn off zero gravity.



2. Full body angle

Press and hold the down button " " or press the right armrest the down button " " of the manual controller to start to adjust the angle of the massage chair downward. The backrest descends and the foot rest rises. Release the button to stop the adjustment;



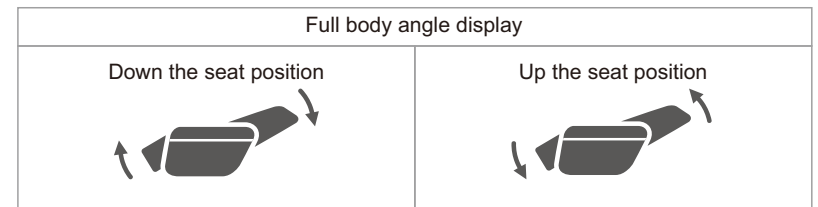

Press and hold the up button " " or press the right armrest the up button " " of the manual controller to adjust the angle of the massage chair upward. The backrest rises and the foot rest falls. Release the button to stop the adjustment.

When the adjustment reaches the limit position, the adjustment will be stopped and a "beep" prompt sound will be issued.



Operation Instructions

3. Foot rest angle

Press and hold the down key "  " or press the right armrest the down key  of foot rest of the manual controller to adjust the angle of the foot rest downward, and release the key to stop the adjustment;
Press and hold the up key "  " or press the right armrest the up key  of the foot rest of the manual controller to adjust the angle of the foot rest upward, and release the button to stop the adjustment.
When the adjustment reaches the limit position, the adjustment will be stopped and a "beep" prompt sound will be issued.

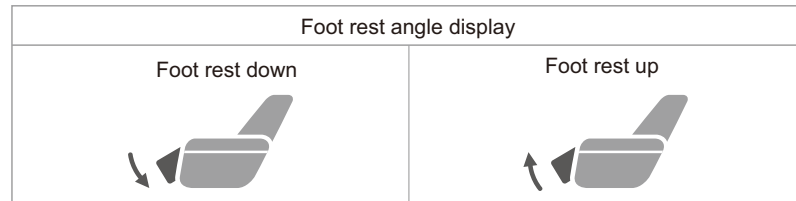

XI. Customise (please use this function after startup)

As shown in the picture below, press the menu key to enter the customise menu interface, select a storage item and press the OK key, then press the OK key "  " on the storage or call item to select to store the current message program or call the stored message program; The same message program cannot be added repeatedly. You can collect up to 3 message programs.

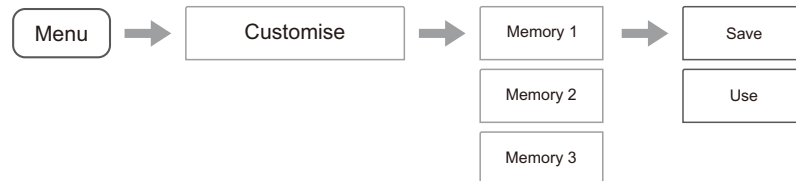



Operation Instructions

XII. System settings (please use this function after startup)

1. Bluetooth, as shown in the picture below, enter the Bluetooth settings menu to turn on or off the Bluetooth audio function. After turning on the Bluetooth audio function, you can play music through connecting smart devices (mobile phones, tablets, etc.). The connection method is as follows:

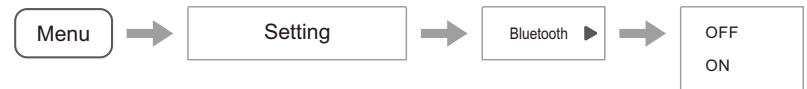
- (1) Open the Bluetooth function on the smart device, search for the Bluetooth name of "IMCM-XXXXX" and connect.
- (2) Open the music player on the smart device to play music.



2. Voice, as shown in the picture below, you can turn on or off the voice assistant function by entering the voice assistant setting menu, or you can turn on or off the voice assistant function by long pressing the voice button "  " on the right armrest. After opening the voice assistant, you can use the voice assistant function to control the massage chair. The use method is as follows:

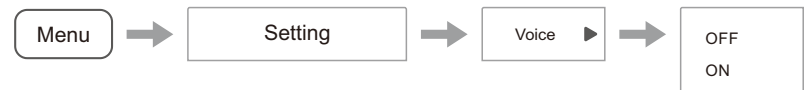

Operation Instructions

- (1) Close to the right horn, say "Alice, Alice" to wake up the voice assistant, or press the right armrest voice button " " to wake up the voice assistant, and the voice assistant replies "please speak " to indicate that it has been awakened.
- (2) After waking up the voice assistant, please speak the command within 6 seconds to realize the function control of the massage chair. After the voice assistant responds to the command, you can continue to speak the command. The interval between two adjacent commands cannot over 6 seconds. Otherwise, you need to wake up the voice assistant again. The detailed voice command table is as follows:

Voice Control Entry		
Entry: "Hi Alice" or "Hey Alice". Answer: I am here.		
No.	Voice control entry	Answer entry
1	Massage on	Answer: Ok, massage on
2	Massage close	Answer: Ok, massage close
3	Comfort massage	Answer: Ok, comfort massage
4	Relax massage	Answer: Ok, relax massage
5	Full body massage	Answer: Ok, full body massage
6	Neck and shoulder massage	Answer: Ok, neck and shoulder massage
7	Back and waist massage	Answer: Ok, back and waist massage
8	Stretch massage	Answer: Ok, stretch massage
9	Fixed massage	Answer: ok, fixed massage
10	Change the other mode	Answer: Ok, change the other mode
11	Go little down	Answer: Ok, go little down
12	Go little up	Answer: Ok, go little up
13	Open the air pressure	Answer: OK, Open the air pressure
14	Close the air pressure	Answer: OK, Close the air pressure
15	Up the seat position	Answer: Ok, Up the seat position
16	Down the seat position	Answer: Ok, Down the seat position
17	Stop adjustment	Answer: Ok, stop adjustment

Operation Instructions

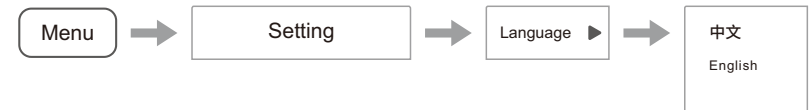

3. Language, as shown in the figure below, into the language settings menu, select Chinese, English settings to choose one language.



4. Serial number, as shown in the picture below, enter the serial number setting menu to view the product serial number.



XIII. Massage close

During the massage, press the hand control switch key " " or the right armrest switch key " " to turn off. Will immediately turn off all massage functions, reset the backrest and leg, or when the massage time is up, the massage automatically turns off all massage functions, and the backrest mechanism and leg mechanism do not reset.

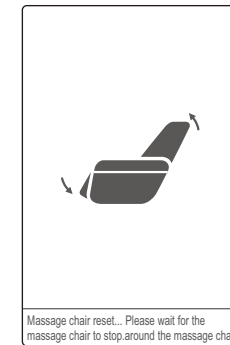

Cut off the power supply of the whole machine, as shown in the attached picture (the schematic diagram of the power cut off of the whole machine).

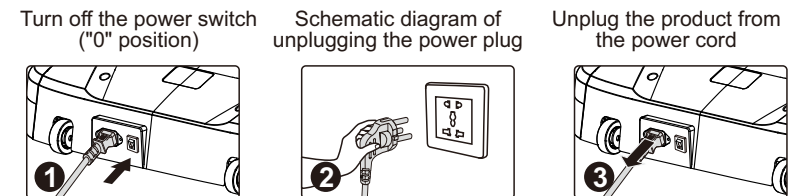

Cleaning And Maintenance

Cleaning synthetic leather and plastic parts

Wipe the leather with a soft, dry cloth.

- Do not use chemicals such as thinner, gasoline, alcohol, etc. to clean the unit.
- When using commercially available leather care products (rags), please follow the instructions for use.
- If synthetic leather is particularly dirty, wipe it in the following way.
 - ① Immerse a soft cloth in water or hot water containing 3% to 5% neutral detergent, then wring it out thoroughly.
 - ② Use the above soft cloth to wipe the leather surface.
 - ③ Wipe off the cleaning solution with a cloth soaked in clean water and thoroughly wring out.
 - ④ Wipe with a wrung soft cloth.
 - ⑤ Let it air dry naturally.
- When it is difficult to remove stains, please immerse commercially available melamine foam in neutral detergent, and then wipe the machine with it.
- Do not use a hair dryer to dry the surface.
- Be careful when wiping the machine with denim and colored fabrics, as the color of the fabric will stain the surface of the synthetic leather.
- Do not keep these parts in contact with plastic for a long time, as this will cause discoloration.
- Synthetic leather may be discolored, so when using hair dye, please cover the touched part with a towel.

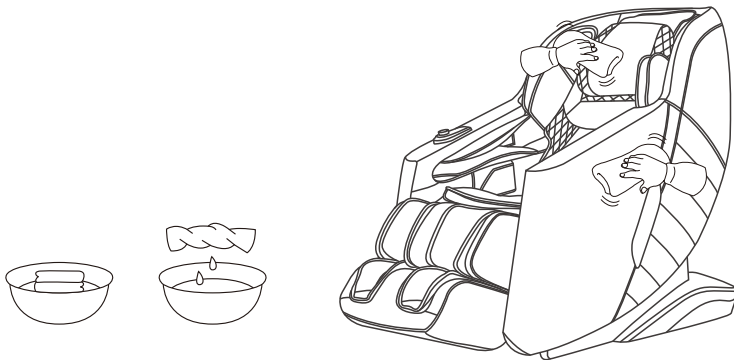

Troubleshooting

Fault	When the calf mechanism or the backrest reaches a certain position, press the corresponding adjustment button and it will no longer change, and a continuous "beep, beep" sound will be emitted.
Solution	Due to product structure design and ergonomic requirements, this product has a limited protection design for the limit state of attitude adjustment. At the same time, a reminder sound will sound when the limit is reached.

Fault	The function does not work or some functions do not work after the machine is turned on.
Solution	After the machine is turned on by pressing the switch key, it is necessary to manually select an automatic massage program or other working state. If it is not operated, the machine will automatically shut down after 20 minutes. If the manual operation mode is selected, the functions that are not selected may be disabled, and the working mode needs to be manually set in the manual mode.

Fault	The machine makes a leather rubbing sound when adjusting its posture.
Solution	This product adopts high-grade anti-corrosion leather that meets environmental protection requirements. Due to the inherent characteristics of leather materials, there will be a normal slight noise when rubbing at the relative movement, which is a normal phenomenon. Note: If you hear fabric or leather tearing sound when the machine is running, please stop using it immediately and seek professional maintenance.

Fault	The massage wheel did not reach the shoulders or neck.
Solution	If the head does not touch the head cushion or the back does not touch the backrest, the shoulder position may be lower than the actual position during the body shape detection process. Sit in the deepest position of the seat, rest your head on the headrest, and start over from the beginning.

Fault	The unit is damaged. The power cord or power plug is abnormally hot.
Solution	To prevent accidents, be sure to contact an authorized service center.

Please feel free to contact the designated service personnel for any questions or doubts about this product.

Product Specification

Model: GM-200 Plus

Name: Massage Chair

Rated voltage: 220-240V~ 50Hz/60Hz

Rated power: 90W

Rated time: 20min

Safety structure: Class I